

Amara Under Counter

WG White Gloss
AMA-BS-450-WG-U

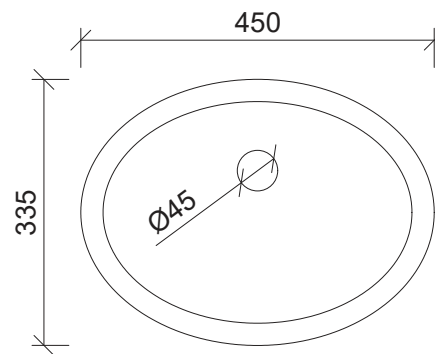

Taphole Offset

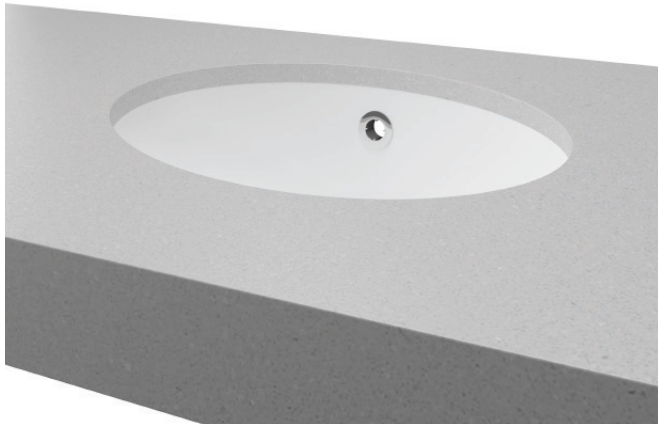
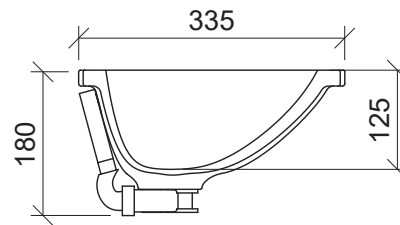
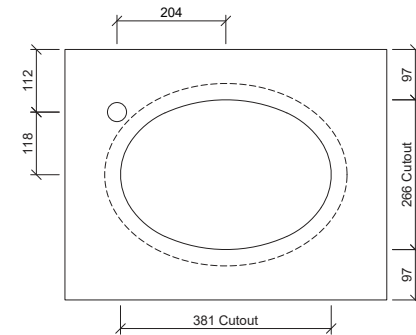

Taphole Behind

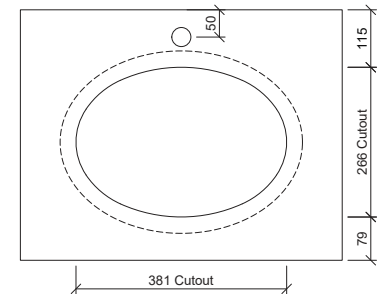

Inset

Drawings

Cut Out Specifications

Material: Mineral Composite

Approx Capacity: 3L

Cut Out Size: 381w x 266d

Waste Size: 40mm with overflow

Note: Waste not included. Refer to brochure for pricing.