

Corrida

WG White Gloss
COR-BS-430-WG-U

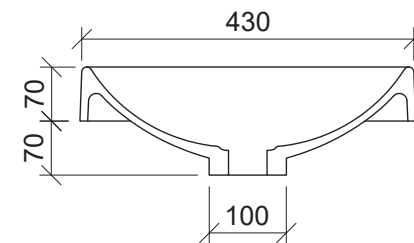

Inset

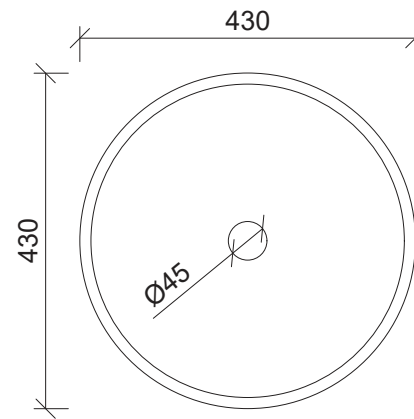

Drawings

Taphole Offset

Note: Offset or wall mounted tapware required.

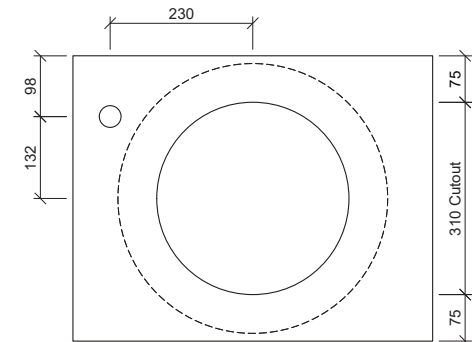

Cut Out Specifications

Material: Mineral Composite
Approx Capacity: 7.9L
Cut Out Size: 310mm
Waste Size: 50mm without overflow

Note: Waste not included. Refer to brochure for pricing.